

Analysis patterns for oil refineries¹

Lei Zhen

Email: zhen_lei@263.net

Guangzhen Shao

Email: shaoguangzhen@salien.com.cn

Beijing Salien Computer Company

Abstract

We present analysis patterns to describe the structure of oil refineries. The Refinery Production Unit Pattern describes the structure of units and unit groups. The Oil Storage Pattern describes the structure of tanks and tank groups. The Oil Delivery Pattern describes the structure of stations for import and export of oil. The Production Process Pattern describes the production process. The audience for this paper includes analysts, designers, and programmers who are involved in developing Refinery Information Systems.

1. Introduction

1.1 Objectives

We have developed information systems for refineries. These systems cover almost every business level of a refinery, from Unit Operation Systems to Decision Assistant Systems. There have been some obstacles for us to finish these projects. One of them is that we lack knowledge about petroleum engineering. Another one is that we are often confused by the same terms having different meanings for different users. We need to study the domain knowledge. But the problem is how much we should know for developing a Refinery Information System?

It is well known that if the developing team members are familiar with the domain knowledge the developing process becomes easier. But petroleum engineering is far from real life. It is hard to explain some terms to our software engineers. It is costly to let software engineers to learn more about refinery process and petroleum engineering. So we decided to develop a series of analysis patterns as a guide for developing Refinery Information Systems. The audience of this work includes analysts, designers, and programmers. The patterns will help them understand the basic knowledge that they must know to perform a project of this type, and give them a generic analysis

¹ Copyright © 2002, Lei Zhen and Guangzhen Shao

Permission is granted to copy for the PLoP 2002 Conference. All other rights reserved.

model that can be a prototype for their concrete analysis.

The patterns of this paper basically describe the structure of refinery. The structure of refinery here means not only its physical structure, but also its logical structures in a business context.

1.2 Overview of the oil refinery patterns

1.2.1 A typical refinery structure

Figure 1 shows the logical structure of a typical refinery. Every type of refinery has three systems: delivery system, storage system and production system. The entities in these three systems and the links (pipes and valves) between them participate in the process of oil production.

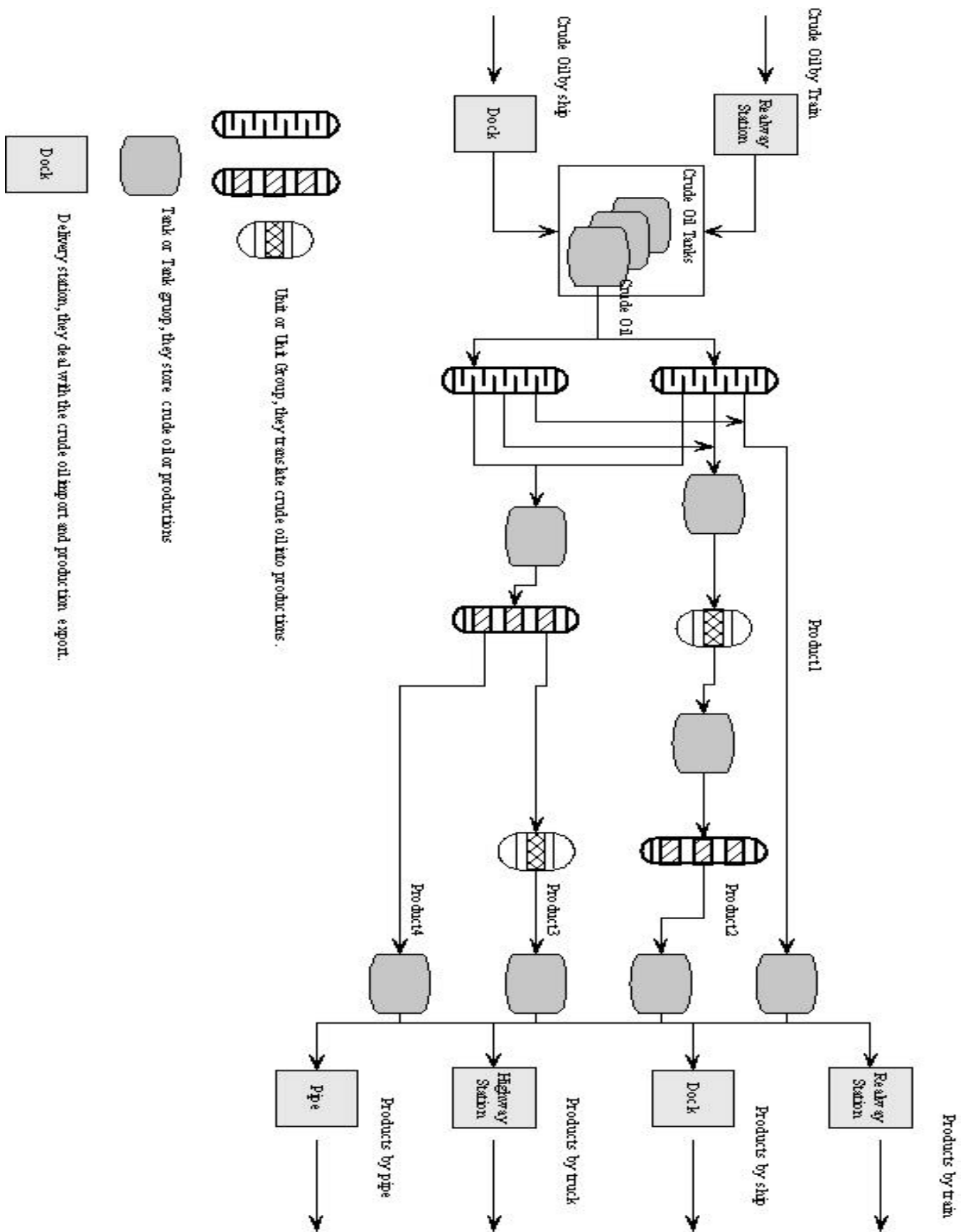

Fig 1: the structure of a typical refinery

The delivery system deals with the crude oil import and production export. It consists of the vehicles that carry the crude oil or production and the stations where the crude oil is imported into the refinery and the production is exported.

The storage system deals with the storage of crude oil, production and semi- production of the production process. It consists of the tanks in a refinery. A tank is a physical entity in the real world. In some business contexts several tanks are treated as a group.

The production system deals with transforming crude oil into production. The production system contains several kinds of units. One unit contains one or several imports and several exports. It consists of several types of equipment. A unit is a physical object in the real world. In some business contexts several units are treated a group.

1.2.2 Oil Refinery Patterns

Four patterns describe the refinery structure (Figure 2). The Refinery Production Unit Pattern describes the structure of production units and unit groups. The Oil Storage Pattern describes the structure of tanks and tank groups. The Oil Delivery Pattern describes the structure of stations for import and export of oil. The Production Process Pattern describes the process of production.

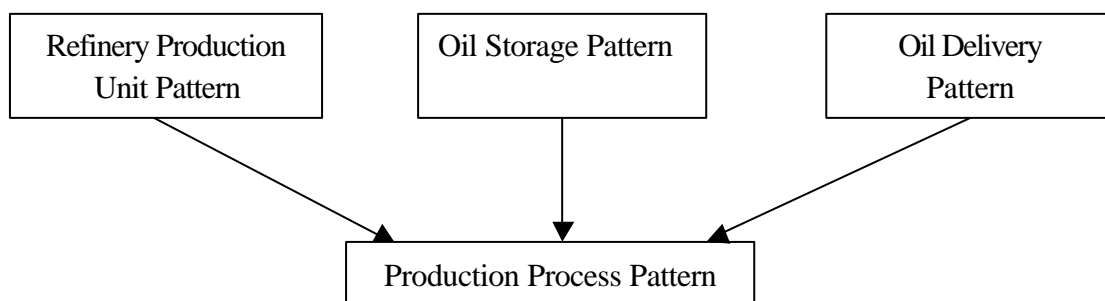

Fig 2: Dependencies between patterns

1.3 Why only static aspects?

There are many analysis patterns in various business domains, e.g. [Fer99]. These patterns treat business processes; however, the patterns presented in this paper only describe static structure of entities in a refinery. The reason for this is that we have found that most mistakes in analysis relate to misunderstanding of the refinery structure. On one the hand, almost all business processes in a refinery depend on the production process. The production process consists of the entities in a refinery e.g. production units, tanks and so on. On the other hand, each business process deals with the production process with its own business rules. The views of the production process are

different in different processes.

We think then that it is important to develop analysis patterns for the structure of entities in a refinery. Structure here means the physical structure in the real world and the logical structure in business contexts. We have left out dynamic aspects that we will consider in another paper.

1.4 Description methods of this paper

We use UML to describe the patterns of this paper [Pag2000] [Lar98]. Although the patterns of this paper are analysis patterns, we have used some design patterns [Gam95] for description methods. To illustrate the structures clearly, we also use some process flow drawings that are used in chemical engineering.

2. Refinery Production Unit Pattern

2.1 Intent

This pattern expresses the structure of unit and unit group. It also expresses the types of unit groups.

2.2 Context

Production units are basic production models of a refinery. They consist of equipment such as towers, stoves, pumps, and so on. Each unit can finish a complete physical and/or chemical process, for example, distillation, catalytic cracking, catalytic reforming, and so on. However, unit groups exist in the business world. They consist of one or more units with some kind of business rules. For example, in a workshop engineer's eyes, the Crude Unit has two imports (the physical structure in real world). But the leader of the statistics department is just concerned about the amount of crude oil that the Crude Unit processes, so in his eyes there is only one import to the Crude Unit.

The business rules of a unit group are often implicative. In many business cases, it is easy to mix unit and unit group, and then some important information is lost. So a conceptual model is needed to describe the structure of units and unit groups and the types of unit groups. The model should also cover various business levels.

2.3 Problem

How to develop a conceptual model of Production Units to describe the units and their relationships at various business levels?

2.4 Forces

- This conceptual model should reflect the structure of production units in various business contexts.
- The type of unit group always includes some business rules.

2.5 Solution

2.5.1 The structure of unit and unit group

Units and unit groups have some common properties and behaviors; for example, material balance. A unit group contains one or more units and may consist of other unit groups. The import or export of a unit group contains one or more imports or exports of units.

We define Unit and Unit Group class as to describe units and unit groups. The Unit Group contains Units or other Unit Groups. We define an abstract class called Abstract Unit that has common properties and behaviors of both Unit and Unit Group. Both Unit and Unit Group are subclasses of it. Define an abstract class called Abstract Unit Import that has common properties and behaviors of the import of both Unit and Unit Group. Define an abstract class called Abstract Unit Export that has common properties and behaviors of the exports of both Unit and Unit Group.

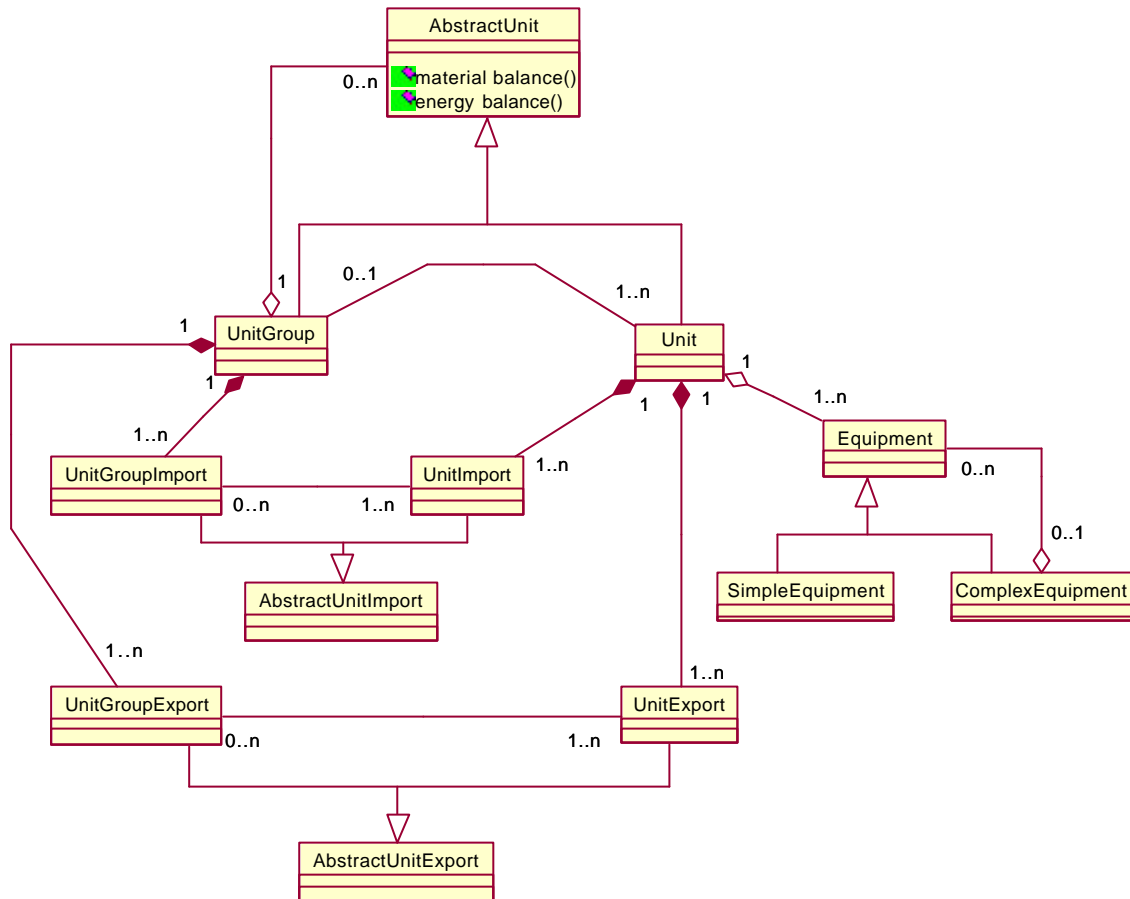

Fig 3 Class diagram of the Refinery Production Unit pattern

Figure 3 shows the class diagram of the Refinery Production Unit Pattern. Both Unit Group and Unit are subclasses of the Abstract Unit. A Unit Group or a Unit has several imports from which the crude materials come in and several exports from which the productions come out.

The relationship between an import (or an export) of a Unit Group and the imports (or exports) of the Units that constitute the Unit Group is more complex. In normal cases, an import or an export of a Unit Group is the composite of imports or exports of Units that constitute the Unit Group. In some special cases as shown in 2.5.2 (2), one import or export of a Unit may relate to more imports or exports of a Unit Group.

A Unit consists of equipment. The structure of equipment is as complex as the unit described here. The details of equipment are left for complementary patterns.

2.5.2 Three kinds of unit groups

Although different business processes consist of units that can be treated as one unit

group with different business rules, the resulting unit group is always one of three types: Simple Unit Group, Statistical Unit Group, and Statistical Unit Group by time.

(1) Simple Unit Group

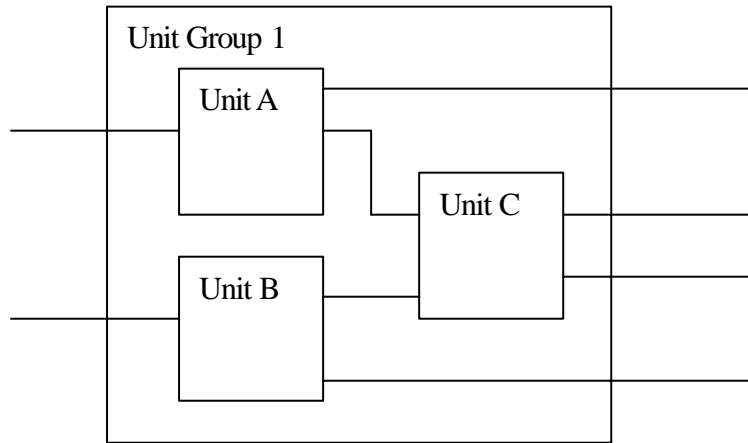
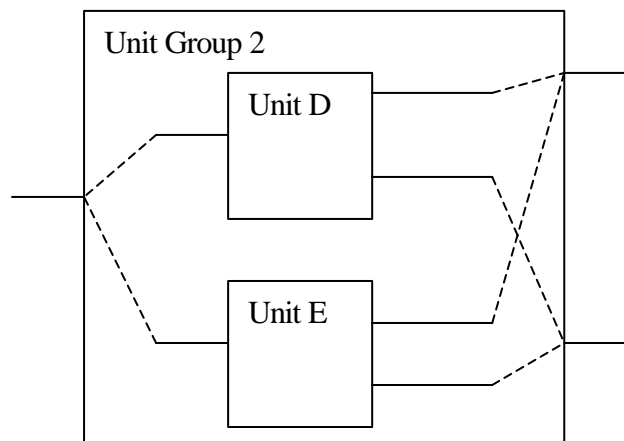

Fig 4 Connection diagram of Simple Unit Group

The Simple Unit Group is easy to understand. It can simplify the production process. The imports and exports of a Unit Group correspond to the imports and exports of the units involved in it.

(2) Statistical Unit Group



(a)

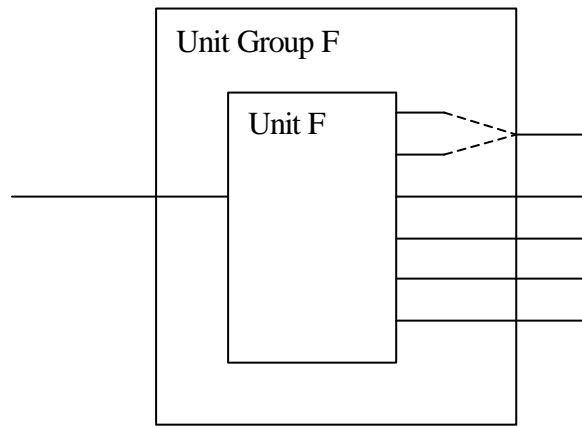

(b)

Fig 5 Diagram of Simple Unit Group

In the case of Statistical Unit Groups, one import (export) of the unit group consists of one or more imports (exports) of the units involved, as shown in Figure 5. The combined imports can be treated as one. The amount of material of the unit group import is the summation of the amount of material of the imports involved. You should notice the case shown in Figure 5(b). It can become a trap if you are not careful. In this case, the unit group usually has the same name of the unit, and most imports (exports) of it correspond to those of the unit exactly. You should distinguish this kind of unit group.

(3) Statistical Unit Group by time

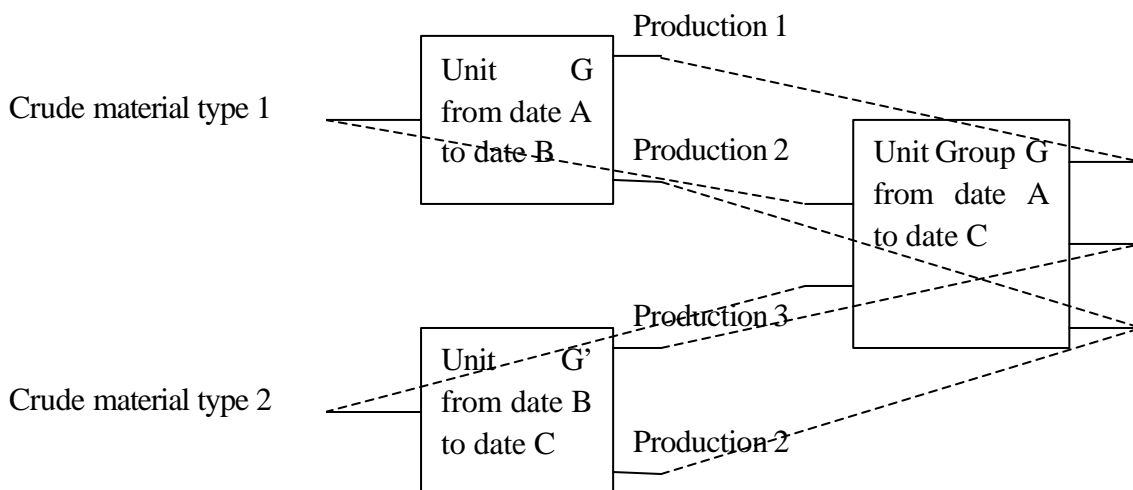

Fig 6 Diagram of Simple Unit Group by time

Consider this case: Unit G can treat two kinds crude material, type 1 and type2. From date A to date B, it treats crude material type 1 and produces productions 1 and 2. From date B to date C, it treats crude material 2 and produces productions 2 and 3. Now the report of the production of Unit G from date A to date C is as shown in the Table 1.

Production Report of Unit G From A To C		
Imports		Amount (t)
	Crude material 1	25
	Crude material 2	30
Exports		
	Production 1	10
	Production 2	30
	Production 3	15

Table 1 Example of Statistical Unit Group by time

In this kind of case, you should treat the unit G as a unit group. The unit group G has two imports and three exports.

2.5.3 How to distinguish the type of the unit group and the business rules

To distinguish a unit group and its type is important for finding business rules. The generic way to do this is shown below.

- (1) List all units. This is easy because the units exist in the real world.
- (2) Find all possible unit groups in the business scope being analyzed. It must be noticed that the “units” in these business scopes should be treated as unit groups, at least at the beginning of analysis.
- (3) Relate the imports/exports of unit and unit group.
- (4) Distinguish the type of unit group.
- (5) List all possible business rules.
- (6) Let end users review these business rules.

There is one thing you should know: the terms, “Unit” and “Unit Group”, defined here are not from end users. In many cases, they only say the same term “unit”. They can distinguish the different meanings by context. So you have to ask them to use the terms defined here when they communicate with you.

2.6 Consequences

This pattern presents the following advantages:

- It defines the generic structure of Production Units of a refinery. It can be used in many applications.
- It can help to distinguish the unit group and its type. That may lead to make some

implied business rules clear.

A disadvantage is that though it can help to make implied business rules clear, it does not make these rules explicit as classes in the structure. They have to be developed for concrete applications.

2.7 Known Uses

This pattern is used in many management systems of oil refineries, e.g. production management systems [ZHA1999].

2.8 Related Patterns

The Unit and Equipment in this pattern are instances of the *Composite pattern* [Gam95].

A Unit has a *Collection* [SAN2001] of Imports and a *Collection* of Exports.

3. Oil Storage Pattern

3.1 Intent

This pattern expresses the structure of tanks or tank groups for reflecting the structure of oil storage system in different business contexts.

3.2 Context

The main equipments for oil storage are tanks. In different business contexts, the scopes of oil storage systems are different. For example, the leader of the statistics department is just concerned about the amount of crude oil, so he takes all tanks of crude oil as one logical tank called crude oil tank group. But a storage engineer should treat each physical tank independently. You want to develop a conceptual model to describe the oil storage system to satisfy all kinds of users.

3.3 Problem

How to describe the structure of oil storage to fit the requirements of different business contexts?

3.4 Forces

- The conceptual model should reflect the structure of oil storage in different business contexts.
- In some business cases, some tanks may be treated as one tank group.

3.5 Solution

We define a Tank class describing tanks in the real world and Tank Group for a group of tanks. We also define an Abstract Tank class that contains their common properties as parent class of both Tank and Tank Group.

The Tank Group contains one or more tanks or other tank Groups. A Tank Group means that there is a common property of all tanks in the group. To distinguish Tank Groups is a good way to make some implied business rules clear. There are two kinds of Tank Group:

- By material type in the tanks. This is the general kind of tank group; for example, the crude oil tank group, and the gas tank group.
- By unit. Most units get material oil from and put production oil to tanks. So one unit may have a material oil tank group and a production oil tank group.

3.6 Structure

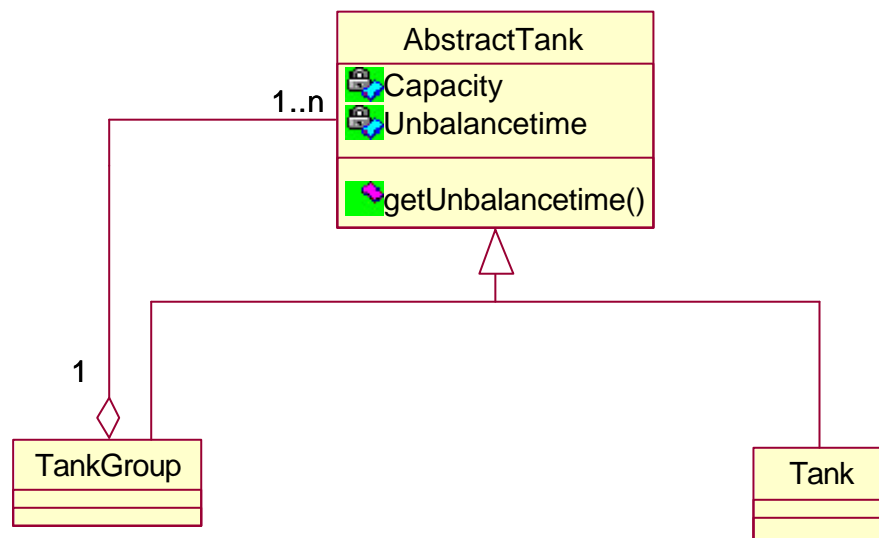

Fig 7: The class diagram of oil storage system

Figure 7 shows the class diagram of the Oil Storage Pattern. The properties and operations in the Abstract Tank class are only used to illustrate that Tank and Tank Group have some common properties and operations. Capacity here means the storage capacity of a tank or a tank group. Unbalance time denotes a phase during which the

tank or tank group will not be empty or full.

3.7 Consequences

This pattern presents the following advantages:

- It defines the typical structure of oil storage system of a refinery. It can be used in applications that include oil storage system.
- It can help to distinguish the Tank Group that means to distinguish the same property of the tanks in that group. It may lead to make some implicative business rules clear.
- The definition of Tank Group can simplify the description of the production process. This will help you describe the production process more clearly.

3.8 Known Uses

This pattern is used in oil storage management system of oil refineries [TIA1995] AND [ZHA1999].

3.9 Related Pattern

This pattern is a specialization of the *Composite pattern* [Gam95].

4. Oil Delivery Pattern

4.1 Intent

This pattern describes the oil delivery system of a refinery.

4.2 Context

The oil delivery system of a refinery includes the crude oil import system and the production export system. The crude oil and production oil may be delivered by railway, highway, ship as well as by pipes. This pattern covers all these kinds of transportation.

4.3 Problem

How to describe the structure of stations for the material imports and production exports of a refinery?

4.4 Forces

- There are many kinds of transportation ways for crude oil import and production

export.

- A station for import or export may have several import or export pipes.

4.5 Solution

We define an Abstract Station class that contains the most common properties and operations of every type of stations. We define Refinery Import class and Refinery Export class for crude oil import and production export. A station may be composed of one or several Refinery Imports and Refinery Exports.

The stations typically are Railway Station, Highway Station, Dock Station, and Pipe Station. We define a Concrete Station class that describes specific types of stations.

4.6 Structure

Figure 8 shows the class diagram of the Oil Delivery Pattern.

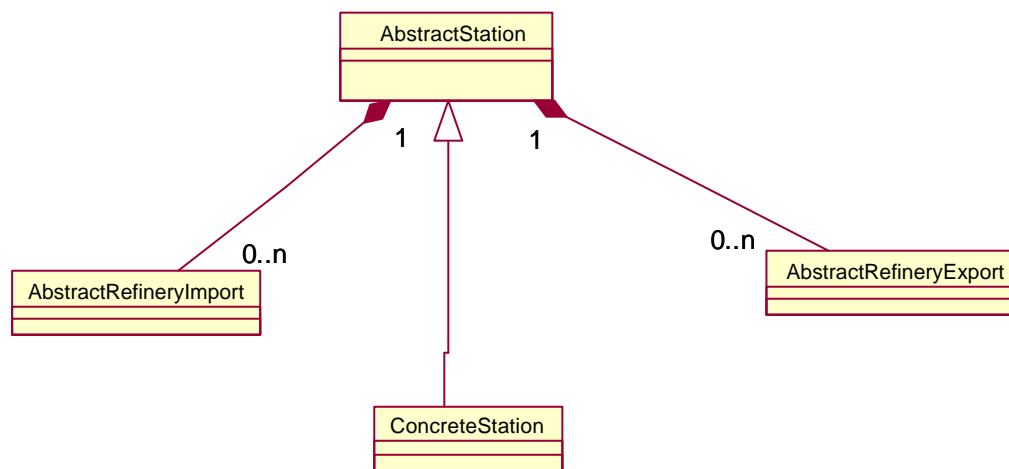

Fig 8 Class diagram for the Oil Delivery pattern

4.7 Consequences

This pattern presents the following advantages:

- It defines the typical structure of oil delivery system for a refinery. It can be used in applications that include oil delivery systems.
- It covers all types of transportation for oil delivery.

4.8 Known Uses

This pattern is used in oil delivery and storage management systems for oil refineries [TIA1995] AND [ZHA1999].

4.9 Related Pattern

A Station has a *Collection* [SAN2001] of Refinery Imports and a *Collection* of Refinery Exports.

5. Production Process Pattern

5.1 Intent

This pattern describes the generic production process of a refinery.

5.2 Context

The production processes of a refinery are changed frequently to satisfy the market requirements. For example, when the price of gasoline becomes higher, the production process will be changed to produce more gasoline and less diesel oil. On the contrary, when the price of diesel oil becomes higher, the production process will be changed to produce more diesel oil and less gasoline. A production process consists of units, tanks, refinery imports/exports and links between them. This pattern deals with the production process.

5.3 Problem

How to describe the generic production process of a refinery?

5.4 Forces

- A production process consists of units, tanks, refinery imports/exports and links between them.
- This pattern is concerned about the logic links in the production process, not concerned about the concrete pipes that compose the link.

5.5 Solution

A production process consists of connection nodes and the links joining these nodes. In the real world, the links consists of pipes and valves. However, in most business contexts, users are only concerned about which two nodes are linked, not about concrete pipes and valves. This means we can use links instead of physical pipes and valves to represent the relationship between two linked nodes. Connection nodes can be an import or export of a unit, a tank, and an import or export of the refinery.

We define a Connection Node class to represent nodes involved in the production process. One Connection Node can connect with several other Connection Nodes through links.

We define an Abstract Link class that represents a logic link between two connection nodes in the process. The Abstract Link has a Begin Node property and an Endpoint property. They represent the two connection nodes involved in the link. If there is more than one connection node involved in one end of a link, we can use a temp node to split it into two links.

A complete process may consist of several subprocesses.

5.6 Structure

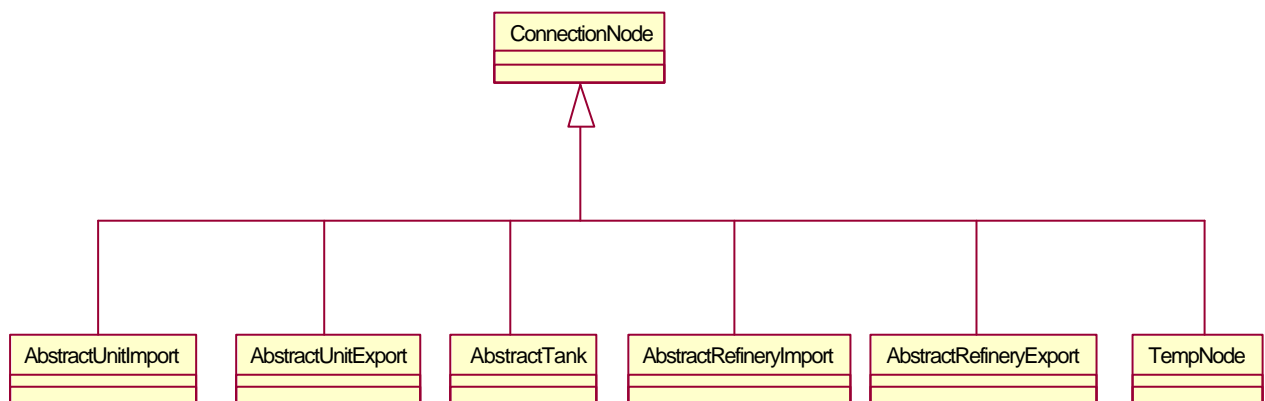

Fig8: Class diagram of a Connection Node

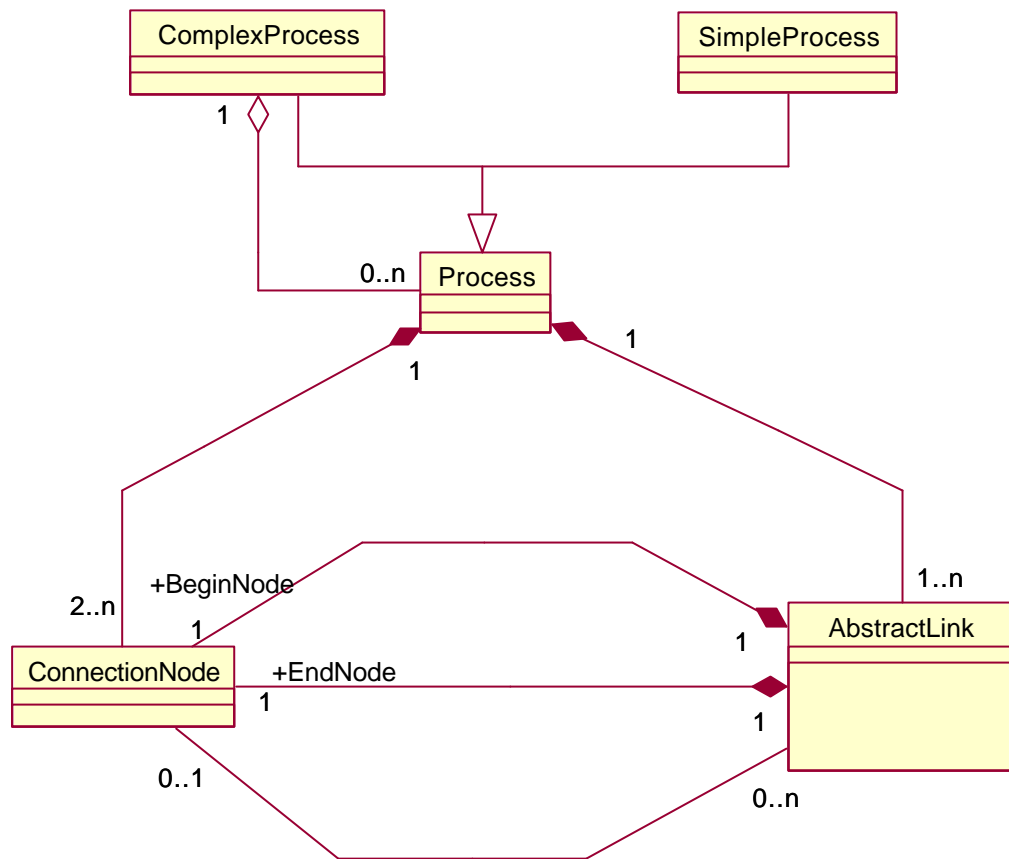

Fig9: The class diagram of Production Process

Figure 8 shows the class diagram of Connection Node pattern. Figure 9 shows the class diagram of the Production process pattern.

5.7 Consequences

This pattern presents the following advantages:

- It defines the generic structure of production processes for a refinery. It can be used in applications that include production processes.
- The definition of subprocess can simplify the description of a production process. This will help you to describe the production process more clearly.

A disadvantage is that the business rules of how to build a production process are not included in this pattern. However, they could be added conveniently.

5.8 Known Uses

These patterns are used in many management systems of oil refineries, e.g. production

management system, delivery management system, and storage management system [TIA1995] AND [ZHA1999].

5.9 Related Pattern

The Process is an example of the *Composite pattern* [Gam95].

A Process has a *Collection* [SAN2001] of Connection Nodes and a *Collection* [SAN2001] of Links.

6. Future work

The patterns in this paper only describe the static structure of a refinery. Based on these patterns, there are many other patterns to deal with concrete applications. We are developing those patterns to build a complete analysis pattern language for a refinery information system. These patterns include:

- Patterns for oil refineries (this paper)
- Patterns for Materials and Productions of Refineries
- Patterns for Refinery Dynamic Production Process
- Patterns for Refinery Production Quality Control
- Patterns for Refinery Equipment Management
- Patterns for Refinery Storage Management
- Patterns for Refinery Delivery Management
- Patterns for Refinery Measurement Management

There are many other businesses involved in a Refinery Information System (such as Manpower Management), but they are not part of the refinery itself.

7. Acknowledgments

Special thanks go to our PLoP shepherd Ed Fernandez for his help and valuable suggestions during the revision of this paper and for encouraging us to be involved in the PLoP conference.

8. References

[Gam95] E. Gamma, R. Helm, R. Johnson and J. Vlissides. Design Patterns: Elements of Reusable Object-oriented Software. Reading, MA: Addison-Wesley, 1995. Chinese version published by CMP.

- [Fer99] E. B. Fernandez and X. Yuan. “An analysis pattern for reservation and use of reusable entities”, Pattern Languages of Programs Conference, PloP99.
<http://st-www.cs.uiuc.edu/~plop/plop99>
- [Pag2000] M. Page-Jones. “Fundamentals of Object-Oriented Design in UML”, Dorset House Publishing 2000. Chinese version published by PPTPH.
- [Lar98] C. Larman. “Applying UML and Patterns: An Introduction to Object-Oriented Analysis and Design”, Prentice Hall PTR 1998. Chinese version published by CMP.
- [Tia1996] S. Tian “The Technology and Management of Oil Refinery Storage and Delivery”, Sinopec Press, China, 1996.
- [Zha1999] Z. Zhang. The Principles and Application of CIMS for Petrochemical Industry: Sinopec Press, China, 1999
- [San2001] D. Sandu, Collection Patterns, PloP 2001